



N-Channel 20 V (D-S) MOSFET

PRODUCT SUMMARY			
V _{DS} (V)	R _{DS(on)} (Ω)	I _D (A) ^a	Q _g (Typ.)
20	0.080 at V _{GS} = 4.5 V	2.8	3.2 nC
	0.090 at V _{GS} = 2.5 V	2.6	
	0.105 at V _{GS} = 1.8 V	2.4	
	0.150 at V _{GS} = 1.5 V	2.0	

FEATURES

- Halogen-free According to IEC 61249-2-21 Definition
- TrenchFET[®] Power MOSFET
- Ultra Small 0.8 mm x 0.8 mm Outline
- Ultra Thin 0.357 mm Height
- Typical ESD Protection 1500 V
- Compliant to RoHS Directive 2002/95/EC



RoHS
COMPLIANT
HALOGEN
FREE

APPLICATIONS

- Portable Devices such as Cell Phones, Smart Phones and MP3 Players
- Load Switch
- Small Signal Switch

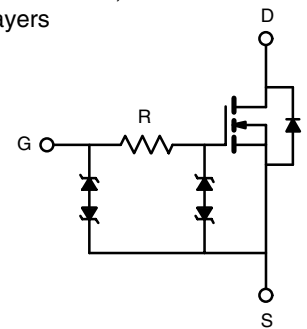

MICRO FOOT

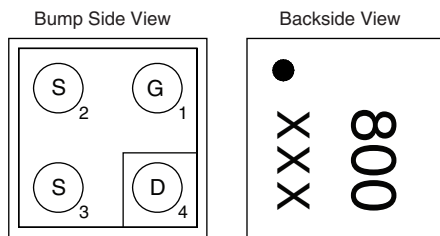

Device Marking: 800
xxx = Date/Lot Traceability Code

Ordering Information: Si8800EDB-T2-E1 (Lead (Pb)-free and Halogen-free)

ABSOLUTE MAXIMUM RATINGS T _A = 25 °C, unless otherwise noted				
Parameter	Symbol	Limit	Unit	
Drain-Source Voltage	V _{DS}	20	V	
Gate-Source Voltage	V _{GS}	± 8		
Continuous Drain Current (T _J = 150 °C)	I _D	T _A = 25 °C	2.8 ^a	A
		T _A = 70 °C	2.2 ^a	
		T _A = 25 °C	2.0 ^b	
		T _A = 70 °C	1.6 ^b	
Pulsed Drain Current	I _{DM}	15		
Continuous Source-Drain Diode Current	I _S	T _A = 25 °C	0.7 ^a	
		T _A = 25 °C	0.4 ^b	
Maximum Power Dissipation	P _D	T _A = 25 °C	0.9 ^a	W
		T _A = 70 °C	0.6 ^a	
		T _A = 25 °C	0.5 ^b	
		T _A = 70 °C	0.3 ^b	
Operating Junction and Storage Temperature Range	T _J , T _{stg}	- 55 to 150	°C	
Soldering Recommendations (Peak Temperature) ^c		260		

THERMAL RESISTANCE RATINGS				
Parameter	Symbol	Typical	Maximum	Unit
Maximum Junction-to-Ambient ^{a, d}	R _{thJA}	105	135	°C/W
Maximum Junction-to-Ambient ^{b, e}		200	260	

Notes:

- Surface mounted on 1" x 1" FR4 board with full copper, t = 5 s.
- Surface mounted on 1" x 1" FR4 board with minimum copper, t = 5 s.
- Refer to IPC/JEDEC (J-STD-020C), no manual or hand soldering.
- Maximum under steady state conditions is 185 °C/W.
- Maximum under steady state conditions is 330 °C/W.

SPECIFICATIONS $T_J = 25\text{ }^\circ\text{C}$, unless otherwise noted							
Parameter	Symbol	Test Conditions	Min.	Typ.	Max.	Unit	
Static							
Drain-Source Breakdown Voltage	V_{DS}	$V_{GS} = 0\text{ V}, I_D = 250\text{ }\mu\text{A}$	20			V	
V_{DS} Temperature Coefficient	$\Delta V_{DS}/T_J$	$I_D = 250\text{ }\mu\text{A}$		18		mV/ $^\circ\text{C}$	
$V_{GS(th)}$ Temperature Coefficient	$\Delta V_{GS(th)}/T_J$			-2.3			
Gate-Source Threshold Voltage	$V_{GS(th)}$	$V_{DS} = V_{GS}, I_D = 250\text{ }\mu\text{A}$	0.4		1.0	V	
Gate-Source Leakage	I_{GSS}	$V_{DS} = 0\text{ V}, V_{GS} = \pm 4.5\text{ V}$			± 0.5	μA	
		$V_{DS} = 0\text{ V}, V_{GS} = \pm 8\text{ V}$			± 6		
Zero Gate Voltage Drain Current	I_{DSS}	$V_{DS} = 20\text{ V}, V_{GS} = 0\text{ V}$			1		
		$V_{DS} = 20\text{ V}, V_{GS} = 0\text{ V}, T_J = 55\text{ }^\circ\text{C}$			10		
On-State Drain Current ^a	$I_{D(on)}$	$V_{DS} \geq 5\text{ V}, V_{GS} = 4.5\text{ V}$	10			A	
Drain-Source On-State Resistance ^a	$R_{DS(on)}$	$V_{GS} = 4.5\text{ V}, I_D = 1.0\text{ A}$		0.066	0.080	Ω	
		$V_{GS} = 2.5\text{ V}, I_D = 1.0\text{ A}$		0.072	0.090		
		$V_{GS} = 1.8\text{ V}, I_D = 1.0\text{ A}$		0.082	0.105		
		$V_{GS} = 1.5\text{ V}, I_D = 0.5\text{ A}$		0.095	0.150		
Forward Transconductance ^a	g_{fs}	$V_{DS} = 10\text{ V}, I_D = 1.0\text{ A}$		10		S	
Dynamic^b							
Total Gate Charge	Q_g	$V_{DS} = 10\text{ V}, V_{GS} = 8\text{ V}, I_D = 1.0\text{ A}$		5.5	8.3	nC	
		$V_{DS} = 10\text{ V}, V_{GS} = 4.5\text{ V}, I_D = 1.0\text{ A}$		3.2	5.0		
Gate-Source Charge	Q_{gs}			0.42			
Gate-Drain Charge	Q_{gd}			0.5			
Gate Resistance	R_g	$f = 1\text{ MHz}$		1.0		k Ω	
Turn-On Delay Time	$t_{d(on)}$	$V_{DD} = 10\text{ V}, R_L = 10\text{ }\Omega$ $I_D \cong 1.0\text{ A}, V_{GEN} = 4.5\text{ V}, R_g = 1\text{ }\Omega$		65	130	ns	
Rise Time	t_r			85	170		
Turn-Off Delay Time	$t_{d(off)}$			900	1800		
Fall Time	t_f			350	700		
Turn-On Delay Time	$t_{d(on)}$	$V_{DD} = 10\text{ V}, R_L = 10\text{ }\Omega$ $I_D \cong 1.0\text{ A}, V_{GEN} = 8\text{ V}, R_g = 1\text{ }\Omega$		25	50		
Rise Time	t_r			40	80		
Turn-Off Delay Time	$t_{d(off)}$			1100	2200		
Fall Time	t_f			350	700		
Drain-Source Body Diode Characteristics							
Continuous Source-Drain Diode Current	I_S	$T_C = 25\text{ }^\circ\text{C}$			0.7	A	
Pulse Diode Forward Current	I_{SM}				15		
Body Diode Voltage	V_{SD}	$I_S = 1.0\text{ A}, V_{GS} = 0\text{ V}$		1.0	1.5	V	
Body Diode Reverse Recovery Time	t_{rr}	$I_F = 1.0\text{ A}, di/dt = 100\text{ A}/\mu\text{s}, T_J = 25\text{ }^\circ\text{C}$		13	25	ns	
Body Diode Reverse Recovery Charge	Q_{rr}				5	10	nC
Reverse Recovery Fall Time	t_a				8		ns
Reverse Recovery Rise Time	t_b				5		

Notes:

- a. Pulse test; pulse width $\leq 300\text{ }\mu\text{s}$, duty cycle $\leq 2\%$
b. Guaranteed by design, not subject to production testing.

Stresses beyond those listed under "Absolute Maximum Ratings" may cause permanent damage to the device. These are stress ratings only, and functional operation of the device at these or any other conditions beyond those indicated in the operational sections of the specifications is not implied. Exposure to absolute maximum rating conditions for extended periods may affect device reliability.



TYPICAL CHARACTERISTICS 25 °C, unless otherwise noted

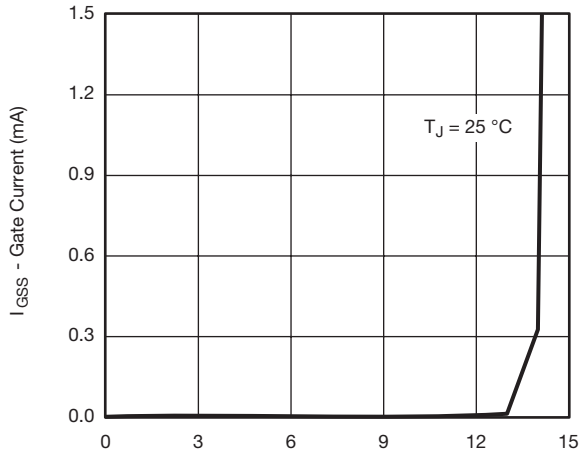

Gate Current vs. Gate-Source Voltage

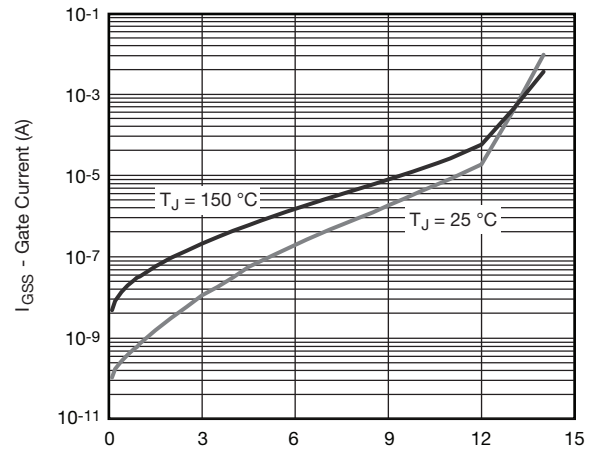

Gate Current vs. Gate-Source Voltage

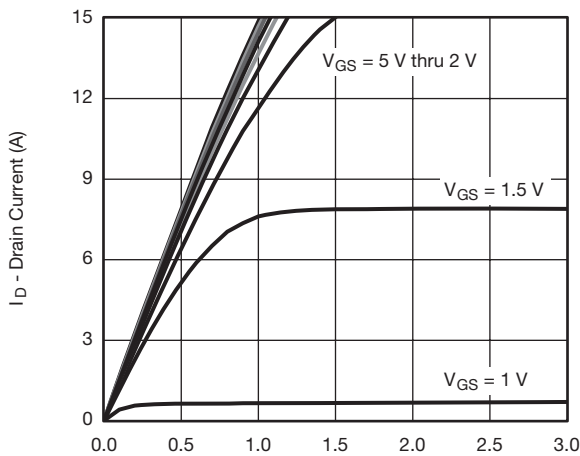

Output Characteristics

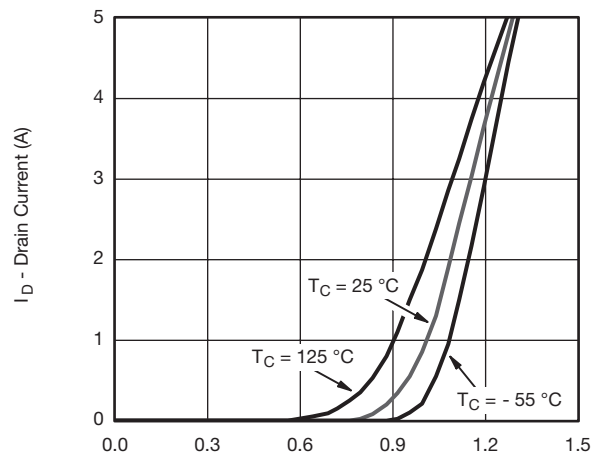

Transfer Characteristics

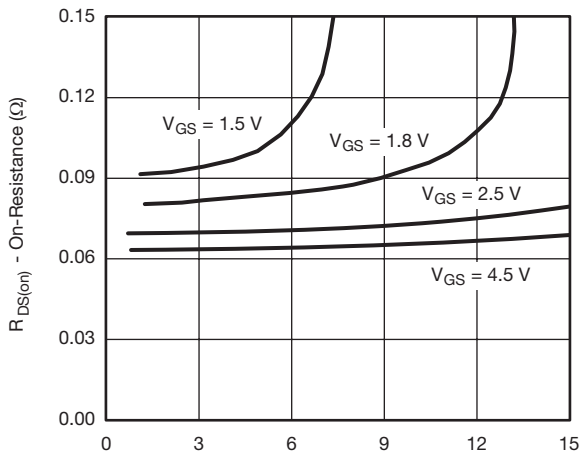

On-Resistance vs. Drain Current

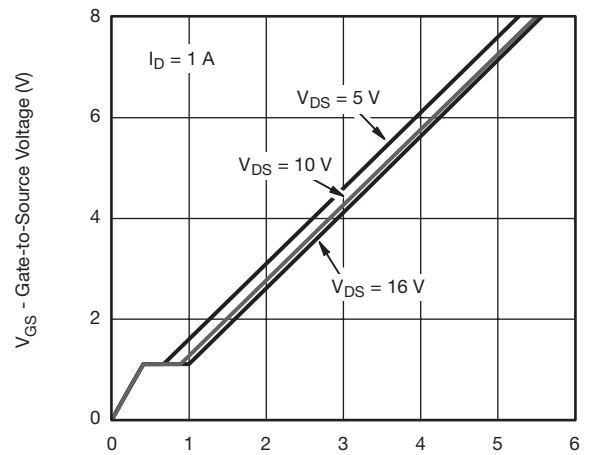

Gate Charge

TYPICAL CHARACTERISTICS 25 °C, unless otherwise noted

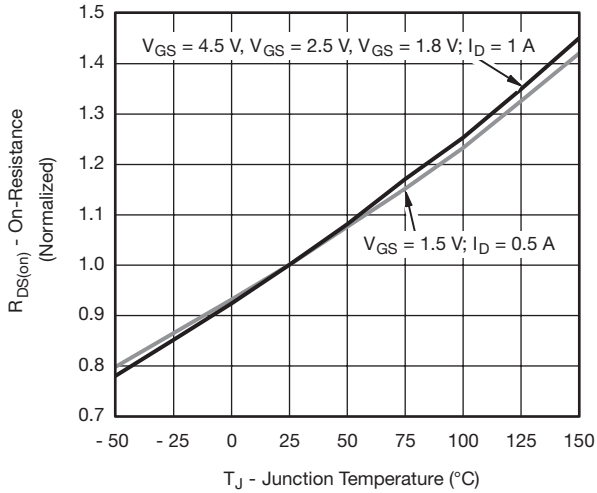

On-Resistance vs. Junction Temperature

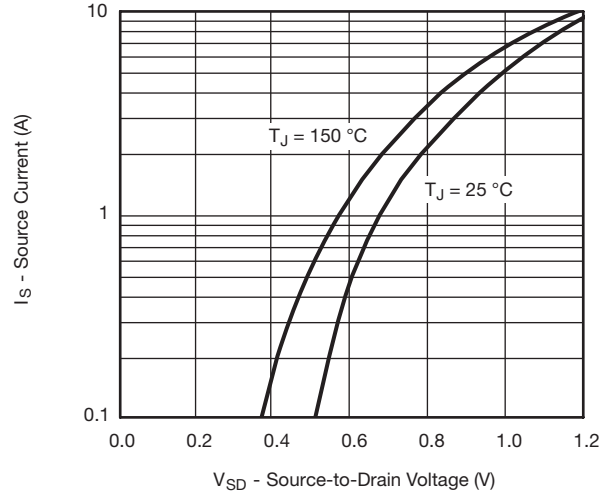

Source-Drain Diode Forward Voltage

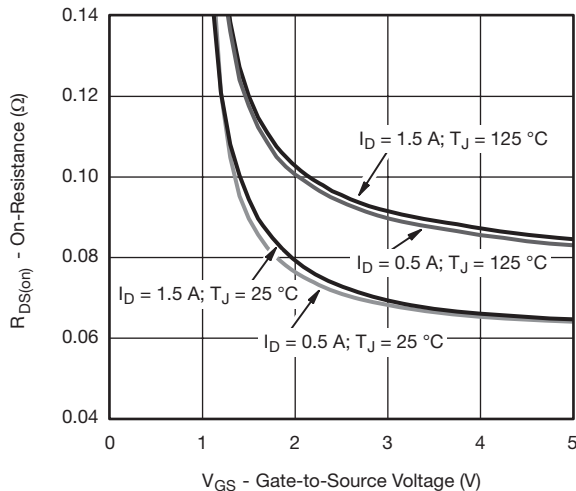

On-Resistance vs. Gate-to-Source Voltage

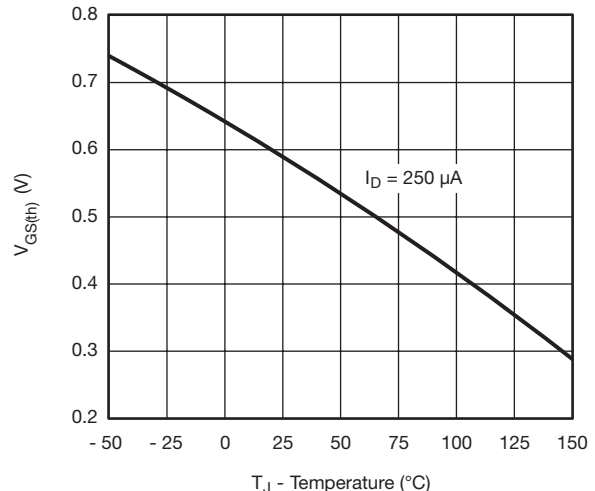

Threshold Voltage

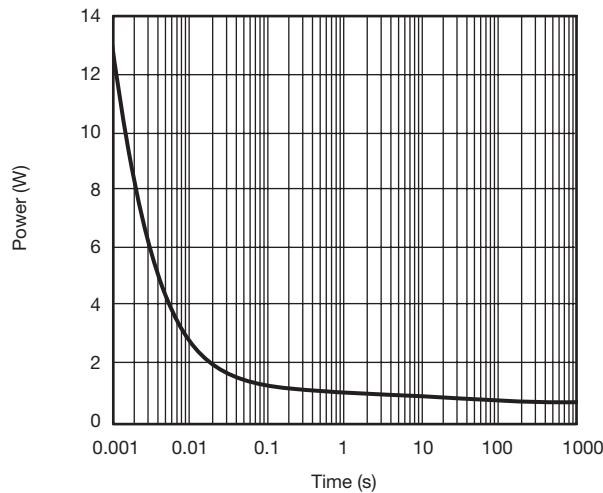

Single Pulse Power (Junction-to-Ambient)



TYPICAL CHARACTERISTICS 25 °C, unless otherwise noted

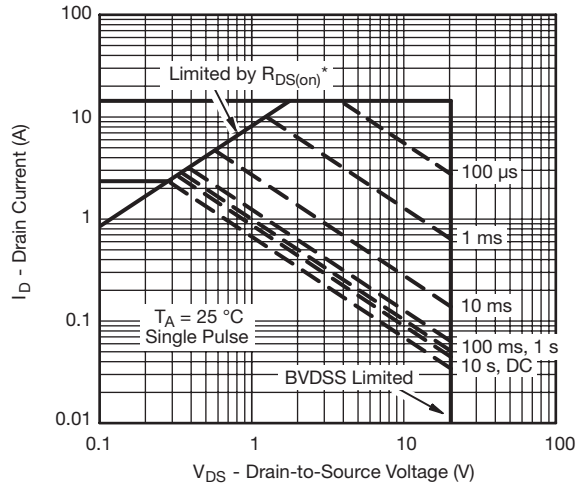

* $V_{GS} >$ minimum V_{GS} at which $R_{DS(on)}$ is specified

Safe Operating Area, Junction-to-Ambient

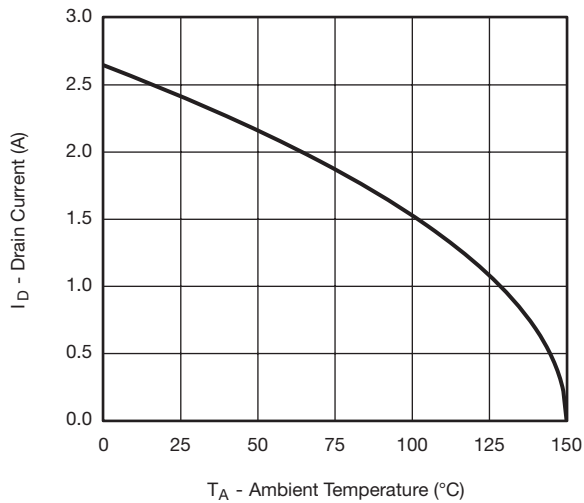

Current Derating*

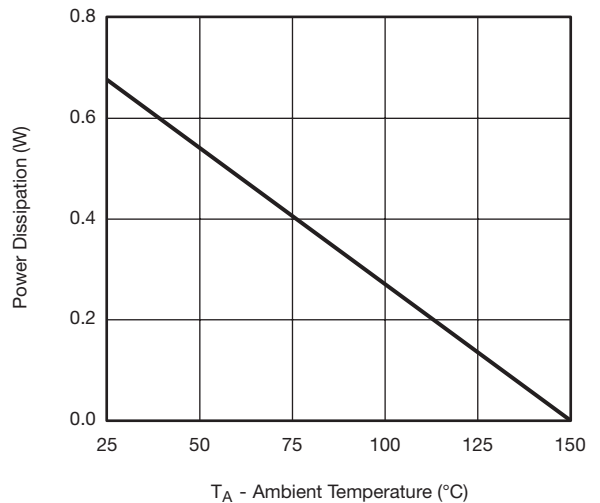

Power Derating

Note:

When mounted on 1" x 1" FR4 with full copper.

* The power dissipation P_D is based on $T_{J(max)} = 150^\circ\text{C}$, using junction-to-ambient thermal resistance, and is more useful in settling the upper dissipation limit for cases where additional heatsinking is used. It is used to determine the current rating, when this rating falls below the package limit.

Si8800EDB

Vishay Siliconix



TYPICAL CHARACTERISTICS 25 °C, unless otherwise noted

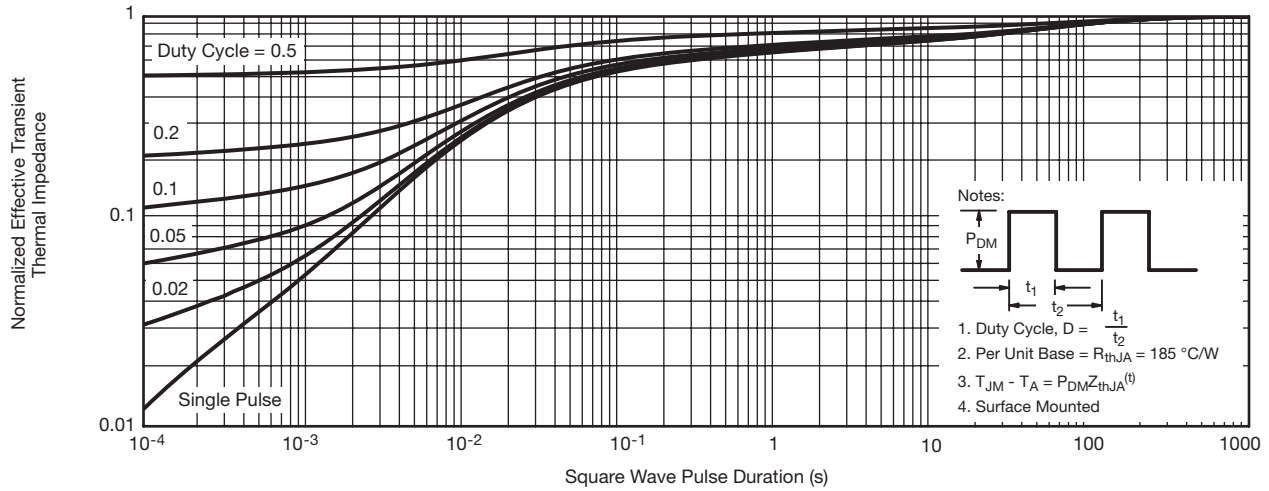

Normalized Thermal Transient Impedance, Junction-to-Ambient (On 1" x 1" FR4 board with maximum copper)

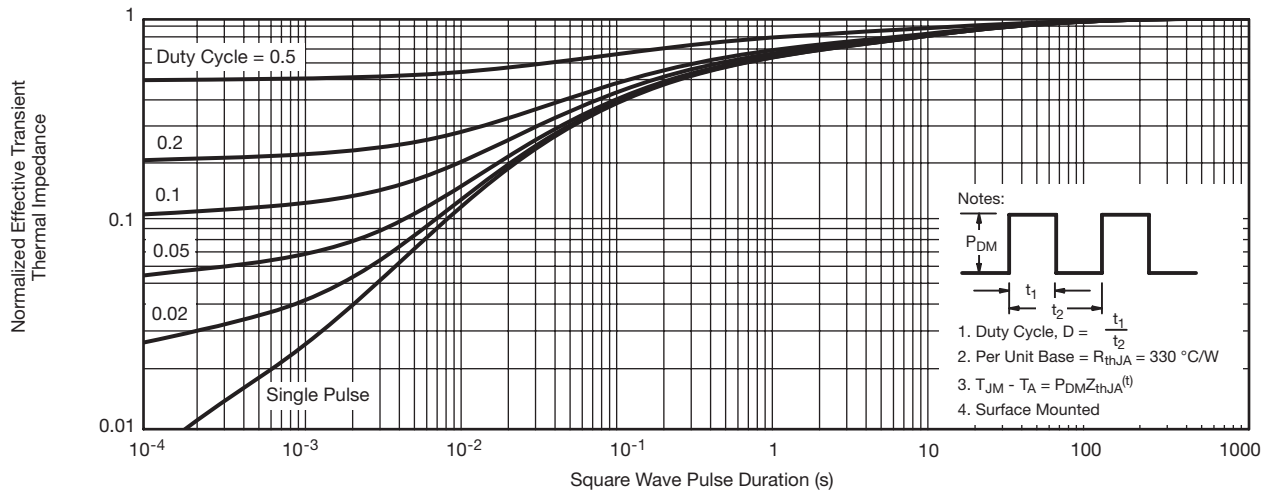

Normalized Thermal Transient Impedance, Junction-to-Ambient (on 1" x 1" FR4 board with minimum copper)

PACKAGE OUTLINE

MICRO FOOT 0.8 mm x 0.8 mm: 4-BUMP (2 x 2, 0.4 mm PITCH)

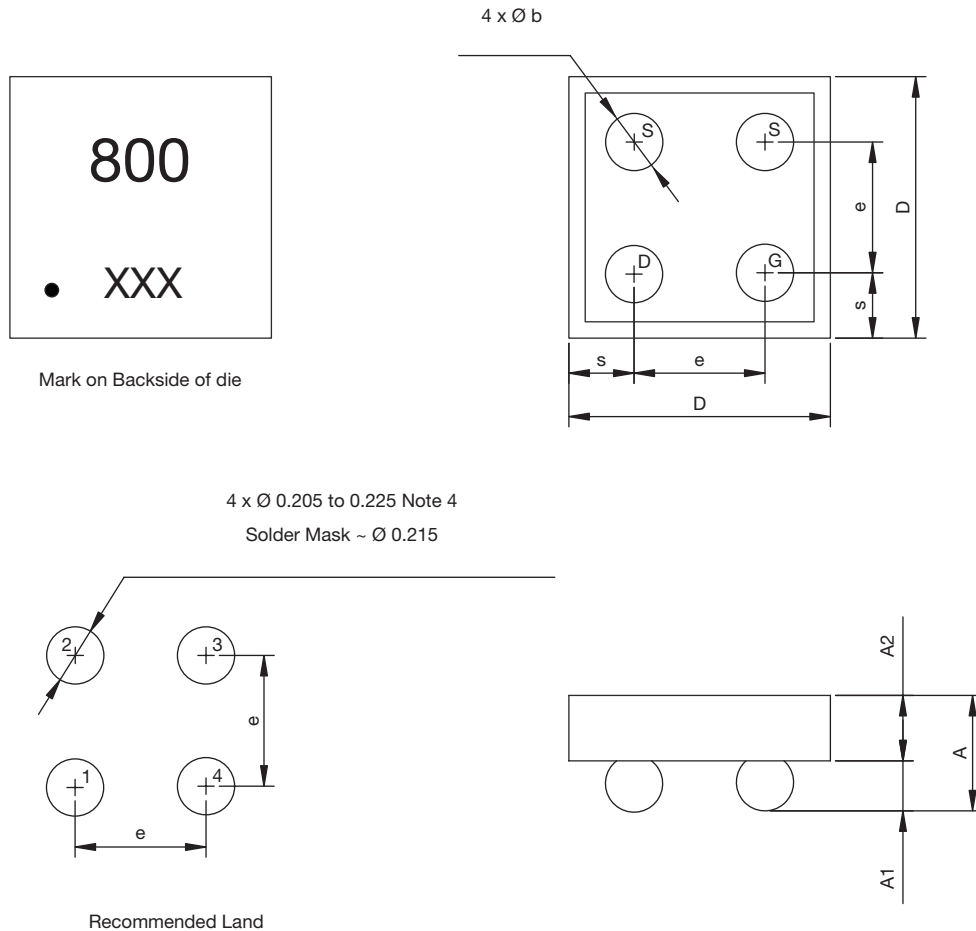

Notes (Unless otherwise specified):

1. All dimensions are in millimeters.
2. Four (4) solder bumps are lead (Pb)-free 95.5Sn/3.5Ag/0.7Cu with diameter \varnothing 0.165 mm to \varnothing 0.185 mm.
3. Backside surface is coated with a Ti/Ni/Ag layer.
4. Non-solder mask defined copper landing pad.
5. • is location of pin 1.

Dim.	Millimeters ^a			Inches		
	Min.	Nom.	Max.	Min.	Nom.	Max.
A	0.314	0.357	0.400	0.0124	0.0141	0.0157
A ₁	0.127	0.157	0.187	0.0050	0.0062	0.0074
A ₂	0.187	0.200	0.213	0.0074	0.0079	0.0084
b	0.165	0.175	0.185	0.0064	0.0068	0.0072
e	0.400			0.0157		
s	0.180	0.200	0.220	0.0070	0.0078	0.0086
D	0.760	0.800	0.840	0.0299	0.0314	0.0330

Notes:

- a. Use millimeters as the primary measurement.

Vishay Siliconix maintains worldwide manufacturing capability. Products may be manufactured at one of several qualified locations. Reliability data for Silicon Technology and Package Reliability represent a composite of all qualified locations. For related documents such as package/tape drawings, part marking, and reliability data, see www.vishay.com/ppg?66700.



Disclaimer

All product specifications and data are subject to change without notice.

Vishay Intertechnology, Inc., its affiliates, agents, and employees, and all persons acting on its or their behalf (collectively, "Vishay"), disclaim any and all liability for any errors, inaccuracies or incompleteness contained herein or in any other disclosure relating to any product.

Vishay disclaims any and all liability arising out of the use or application of any product described herein or of any information provided herein to the maximum extent permitted by law. The product specifications do not expand or otherwise modify Vishay's terms and conditions of purchase, including but not limited to the warranty expressed therein, which apply to these products.

No license, express or implied, by estoppel or otherwise, to any intellectual property rights is granted by this document or by any conduct of Vishay.

The products shown herein are not designed for use in medical, life-saving, or life-sustaining applications unless otherwise expressly indicated. Customers using or selling Vishay products not expressly indicated for use in such applications do so entirely at their own risk and agree to fully indemnify Vishay for any damages arising or resulting from such use or sale. Please contact authorized Vishay personnel to obtain written terms and conditions regarding products designed for such applications.

Product names and markings noted herein may be trademarks of their respective owners.